



Leaded varistors

AdvanceD-MP series

Series/Type: SIOV-S10K***E2K1
Ordering code: B72210P2**1K101
Date: 2010-02-02
Version: e

Applications

Overvoltage protection

Features

- UL approval to UL1449 (file number E321126), for use in Type 3 SPD's
- Designed to meet the surge requirements of IEC 60950-1 Annex Q and IEC 60065 § 14.12
- Wide operating voltage range 175 ... 680 V_{RMS}
- Ideally suited for AC applications where low level repetitive surges are expected

SIOV nomenclature

S	=	Disk type
10	=	Rated disk diameter
K	=	Tolerance of V _V at 1 mA: ±10%
***	=	Max. AC voltage
E2K1	=	AdvanceD-MP series

General technical data

Climatic category	to IEC 60068-1	40/85/56	
Operating temperature	to CECC 42 000	-40 ... + 85	°C
Storage temperature		-40 ... +125	°C
Electric strength	to CECC 42 000	≥2.5	kV _{RMS}
Insulation resistance	to CECC 42 000	≥10	MΩ
Response time		<25	ns

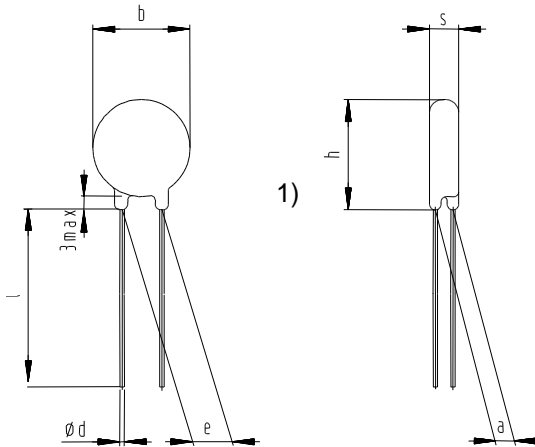
Dimensional drawings in mm

b_{\max}	=	See table below
h_{\max}	=	See table below
s_{\max}	=	See table below
$e \pm 1$	=	7.5
$a \pm 1$	=	See table below
l_{\min}	=	25.0
$\varnothing d \pm 0.05$	=	0.8

1) seating plane in accordance with IEC 60717

Dimensions

Ordering code	Type	b_{\max} [mm]	h_{\max} [mm]	s_{\max} [mm]	$a \pm 1$ [mm]
B72210P2171K101	S10K175E2K1	12.0	16.0	5.1	2.4
B72210P2271K101	S10K275E2K1	12.0	16.0	5.9	3.2
B72210P2301K101	S10K300E2K1	12.0	16.0	6.1	3.5
B72210P2321K101	S10K320E2K1	12.0	16.0	6.3	3.7
B72210P2351K101	S10K350E2K1	12.5	16.5	6.7	4.0
B72210P2381K101	S10K385E2K1	12.5	16.5	7.7	4.3
B72210P2421K101	S10K420E2K1	12.5	16.5	8.1	4.6
B72210P2461K101	S10K460E2K1	12.5	16.5	8.4	5.0
B72210P2511K101	S10K510E2K1	13.0	17.0	8.8	5.3
B72210P2551K101	S10K550E2K1	13.0	17.0	9.3	5.8
B72210P2621K101	S10K625E2K1	13.0	17.0	9.8	6.3
B72210P2681K101	S10K680E2K1	13.0	17.0	10.4	6.9

Electrical data

Maximum ratings (85 °C)

Ordering code	Type SIOV- S10K	V _{RMS} [V]	V _{DC} [V]	i _{max} (8/20 μs) 1 time [A]*	W _{max} (2 ms) 1 time [J]	P _{max} [W]
B72210P2171K101	175E2K1	175	225	3500	40	0.4
B72210P2271K101	275E2K1	275	350	3500	60	0.4
B72210P2301K101	300E2K1	300	385	3500	65	0.4
B72210P2321K101	320E2K1	320	420	3500	72	0.4
B72210P2351K101	350E2K1	350	460	3500	77	0.4
B72210P2381K101	385E2K1	385	505	3500	82	0.4
B72210P2421K101	420E2K1	420	560	3500	87	0.4
B72210P2461K101	460E2K1	460	615	3500	92	0.4
B72210P2511K101	510E2K1	510	670	3500	92	0.4
B72210P2551K101	550E2K1	550	745	3500	97	0.4
B72210P2621K101	625E2K1	625	825	3500	105	0.4
B72210P2681K101	680E2K1	680	895	3500	115	0.4

Characteristics (25 °C)

Ordering code	Type SIOV- S10K	V _v (1 mA) [V]	ΔV _v (1 mA) [%]	Max clamping voltage		C _{typ} (1 kHz) [pF]	Duty cycle surge rating (8/20 μs)	
				V _c [V]	I _c [A]		3 kA* times	750 A* times
B72210P2171K101	175E2K1	270	±10	455	25	360	5	80
B72210P2271K101	275E2K1	430	±10	710	25	180	5	80
B72210P2301K101	300E2K1	470	±10	775	25	175	5	80
B72210P2321K101	320E2K1	510	±10	840	25	170	5	80
B72210P2351K101	350E2K1	560	±10	910	25	150	5	80
B72210P2381K101	385E2K1	620	±10	1025	25	145	5	80
B72210P2421K101	420E2K1	680	±10	1120	25	125	5	80
B72210P2461K101	460E2K1	750	±10	1240	25	105	5	80
B72210P2511K101	510E2K1	820	±10	1355	25	100	5	25
B72210P2551K101	550E2K1	910	±10	1500	25	90	5	25
B72210P2621K101	625E2K1	1000	±10	1650	25	80	5	25
B72210P2681K101	680E2K1	1100	±10	1815	25	75	5	25

*The specified current value shows the actual 8/20 μs peak current throughout the varistor, not the combination wave form.

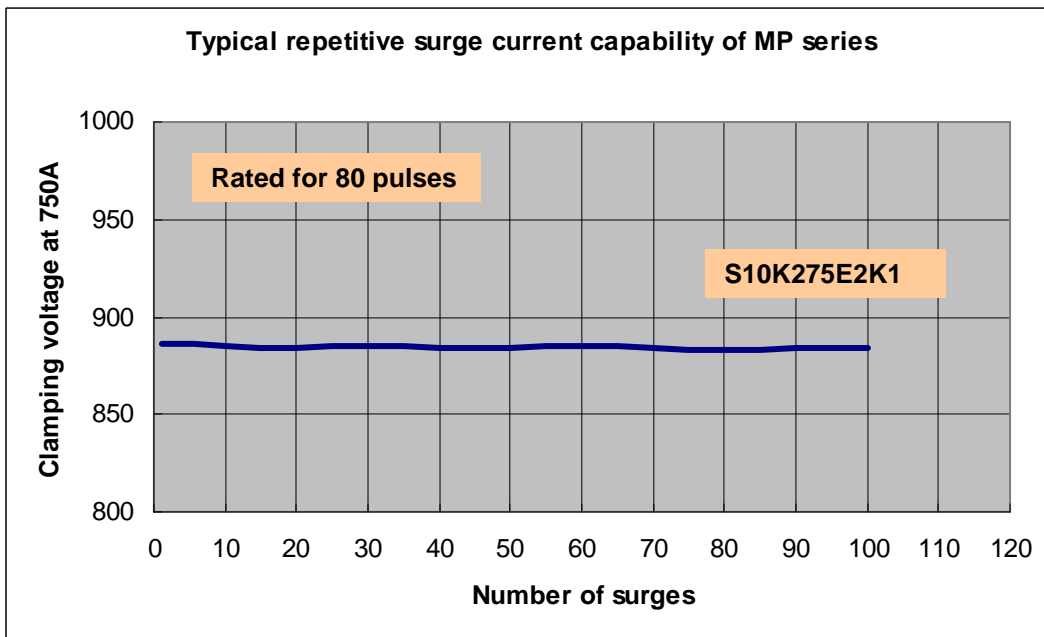
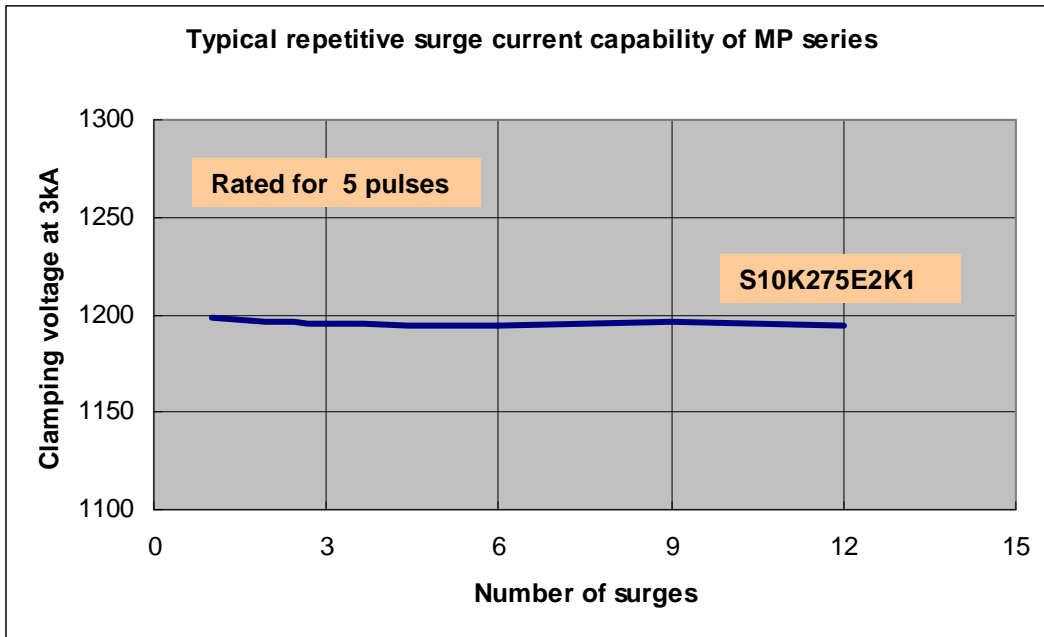

v/i characteristic

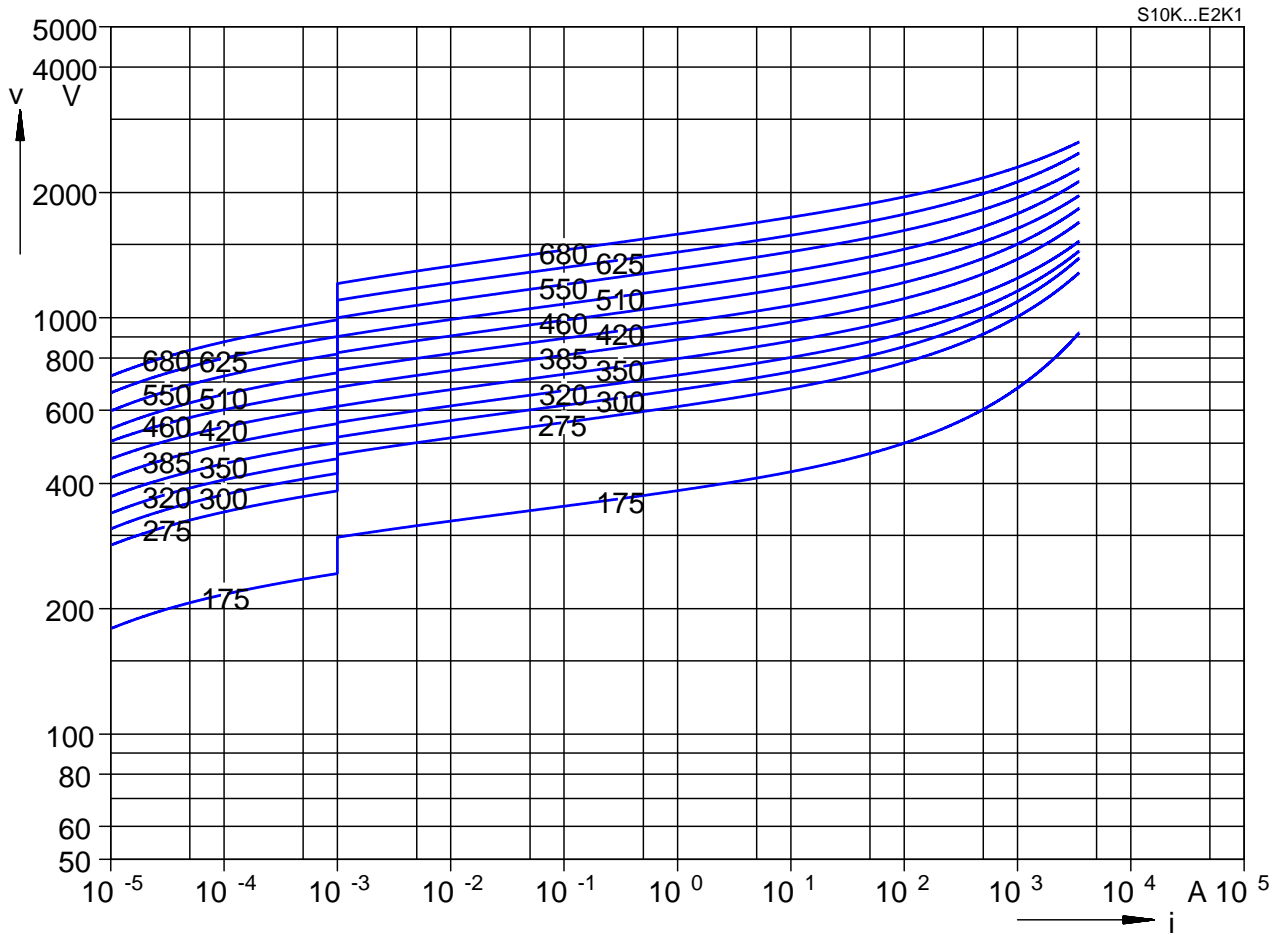

Derating curves (the specified current value in derating curve is the actual peak current throughout the varistor)

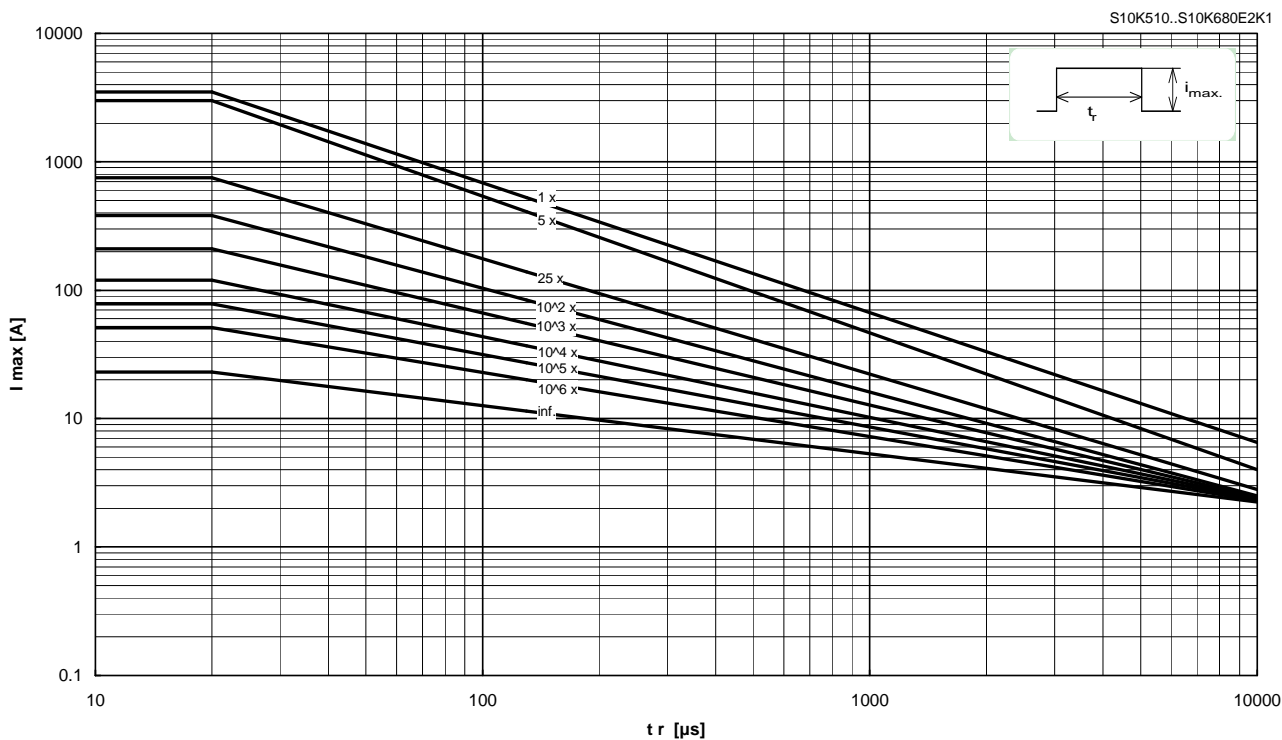
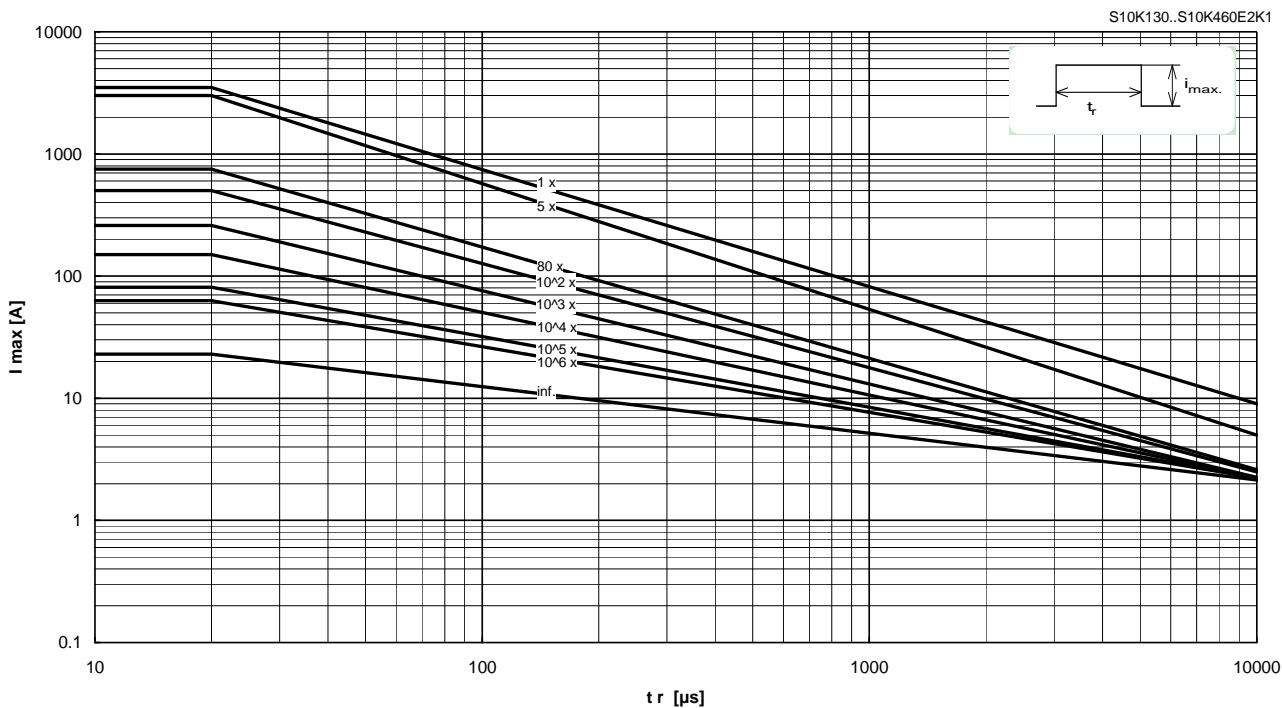

Reliability data electrical

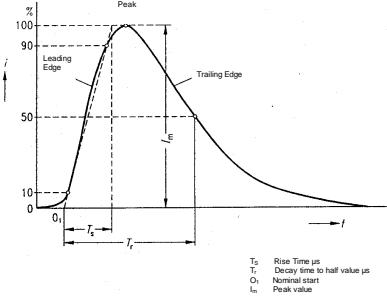
Characteristics	Test methods/Description	Specifications
Varistor voltage	The voltage between two terminals with the specified measuring current applied is called V_V (1 mA _{DC} @ 0.2 ... 2 s).	To meet the specified value
Clamping voltage	The maximum voltage between two terminals with the specified standard impulse current (8/20 μ s) illustrated below applied. 	To meet the specified value
Surge current derating, 8/20 μ s	CECC 42 000, test C 2.1 100 surge currents (8/20 μ s), unipolar, interval 30 s, amplitude corresponding to derating curve for 100 impulses at 20 μ s	$ \Delta V/V (1 \text{ mA}) \leq 10\%$ (measured in direction of surge current) No visible damage
Surge current derating, 2 ms	CECC 42 000, test C 2.1 100 surge currents (2 ms), unipolar, interval 120 s, amplitude corresponding to derating curve for 100 impulses at 2 ms	$ \Delta V/V (1 \text{ mA}) \leq 10\%$ (measured in direction of surge current) No visible damage

Reliability data mechanical

Characteristics	Test methods/Description	Specifications
Tensile strength	IEC 60068-2-21, test Ua1 After gradually applying the force specified below and keeping the unit fixed for 10 s, the terminal shall be visually examined for any damage. Force for wire diameter: 1.0 mm = 20 N	$ \Delta V/V (1 \text{ mA}) \leq 5\%$ No break of solder joint, no wire break
Vibration	IEC 60068-2, test Fc Frequency range: 10 ... 55 Hz Amplitude: 0.75 mm or 98 m/s ² Duration: 6 h (3 x 2 h) Pulse: sine wave After repeatedly applying a single harmonic vibration according to the table above, the change of V_v shall be measured and the part shall be visually examined.	$ \Delta V/V (1 \text{ mA}) \leq 5\%$ No visible damage
Solderability	IEC 60068-2-20, test Ta, method 1 with modified conditions for lead-free solder alloys: 245 °C, 3 s: After dipping the terminals to a depth of approximately 3 mm from the body in a soldering bath of 245 °C for 3 s, the terminals shall be visually examined.	The inspection shall be carried out under adequate light with normal eyesight or with the assistance of a magnifier capable of giving a magnification of 4 to 10 times. The dipped surface shall be covered with a smooth and bright solder coating with no more than small amounts of scattered imperfections such as pinholes or un-wetted or de-wetted areas. These imperfections shall not be concentrated in one area.

Characteristics	Test methods/Description	Specifications
Resistance to soldering heat	IEC 60068-2-20, test Tb, method 1A, 260 °C, 10 s: Each lead shall be dipped into a solder bath having a temperature of 260 ±5 °C to a point 2.0 to 2.5 mm from the body of the unit, be held there for 10 ±1 s and then be stored at room temperature and normal humidity for 1 to 2 hours. The change of V_v shall be measured and the part shall be visually examined.	$ \Delta V/V (1 \text{ mA}) \leq 5\%$ No visible damage
Bump	IEC 60068-2-29, test Eb Pulse duration: 6 ms Max. acceleration: 400 m/s ² Number of bumps: 4000 Pulse: half sine	$ \Delta V/V (1 \text{ mA}) \leq 5\%$ No visible damage
Flammability	IEC 60695-2-2 (needle flame test) Severity: vertical 10 s	5 s maximum
Electric strength	CECC 42 000, test 4.7 Metal balls method, 2500 V _{RMS} , 60 s The varistor is placed in a container holding 1.6 ±0.2 mm diameter metal balls such that only the terminations of the varistor are protruding. The specified voltage shall be applied between both terminals of the specimen connected together and the electrode inserted between the metal balls.	No breakdown

Reliability data environmental

Characteristics	Test methods/Description	Specifications
Max. AC operating voltage	CECC 42 000, test 4.20 1000 h at UCT After having continuously applied the maximum allowable voltage at UCT ± 2 °C for 1000 h, the specimen shall be stored at room temperature and normal humidity for 1 to 2 h. Thereafter, the change of V_v shall be measured.	$ \Delta V/V (1 \text{ mA}) \leq 10\%$
Damp heat, steady state	The specimen shall be subjected to 40 ± 2 °C, 90 to 95% r.H. for 56 days without load / with 10% of the maximum continuous DC operating voltage V_{DC} . Then stored at room temperature and normal humidity for 1 to 2 h. Thereafter, the change of V_v shall be measured. Thereafter, insulation resistance R_{ins} shall be measured according to CECC 42 000, test 4.8 at $V = 500$ V.	$ \Delta V/V (1 \text{ mA}) \leq 10\%$ $R_{ins} \geq 1 \text{ M}\Omega$
Climatic sequence	CECC 42 000, test 4.16 The specimen shall be subjected to: a) dry heat at UCT, 16 h b) damp heat, 1st cycle: 55 °C, 93% r.H., 24 h c) cold, LCT, 2 h d) damp heat, additional 5 cycles: 55 °C/25 °C, 93% r.H., 24 h/cycle. Then the specimen shall be stored at room temperature and normal humidity for 1 to 2 h. Thereafter, the change of V_v shall be measured. Thereafter, insulation resistance R_{ins} shall be measured according to CECC 42 000, test 4.8 at $V = 500$ V.	$ \Delta V/V (1 \text{ mA}) \leq 10\%$ $R_{ins} \geq 1 \text{ M}\Omega$
Fast temperature cycling	IEC 60068-2-14, test Na, LCT/UCT, dwell time 30 min, 5 cycles	$ \Delta V/V (1 \text{ mA}) \leq 5\%$ No visible damage

Note:

UCT = Upper category temperature

LCT = Lower category temperature

 R_{ins} = Insulation resistance to CECC 42 000, test 4.8

Cautions and warnings

General

1. EPCOS metal oxide varistors (SIOVs) are designed for specific applications and should not be used for purposes not identified in our specifications, application notes and data books unless otherwise agreed with EPCOS during the design-in-phase.
2. Ensure suitability of SIOVs through reliability testing during the design-in phase. The SIOVs should be evaluated taking into consideration worst-case conditions.
3. For applications of SIOVs in line-to ground circuits based on various international and local standards there are restrictions existing or additional safety measures required.

Storage

1. Store SIOVs only in original packaging. Do not open the package before storage.
2. Storage conditions in original packaging:

Storage temperature:	-25 °C ... +45 °C
Relative humidity:	<75% annual average, <95% on maximum 30 days a year.
Dew precipitation:	Is to be avoided.
3. Avoid contamination of SIOVs surface during storage, handling and processing.
4. Avoid storage of SIOVs in harmful environments which can affect the function during long-term operation (examples given under operation precautions).
5. The SIOV type series should be soldered within the time specified.

SIOV-S, -Q, -LS	24 month
ETFV and SFS types	12 month.

Handling

1. SIOVs must not be dropped.
2. Components must not be touched with bare hands. Gloves are recommended.
3. Avoid contamination of the surface of SIOV electrodes during handling, be careful of the sharp edge of SIOV electrodes.

Soldering (where applicable)

1. Use rosin-type flux or non-activated flux.
2. Insufficient preheating may cause ceramic cracks.
3. Rapid cooling by dipping in solvent is not recommended.
4. Complete removal of flux is recommended.

Mounting

1. Potting, sealing or adhesive compounds can produce chemical reactions in the SIOV ceramic that will degrade the component's electrical characteristics.
2. Overloading SIOVs may result in ruptured packages and expulsion of hot materials. For this reason the SIOVs should be physically shielded from adjacent components.

Operation

1. Use SIOVs only within the specified temperature operating range
2. Use SIOVs only within the specified voltage and current ranges.
3. Environmental conditions must not harm the SIOVs. Use SIOVs only in normal atmospheric conditions. Avoid use in the presence of deoxidizing gases (chlorine gas, hydrogen sulfide gas, ammonia gas, sulfuric acid gas, etc), corrosive agents, humid or salty conditions, Avoid contact with any liquids and solvents.

Important notes

The following applies to all products named in this publication:

1. Some parts of this publication contain **statements about the suitability of our products for certain areas of application**. These statements are based on our knowledge of typical requirements that are often placed on our products in the areas of application concerned. We nevertheless expressly point out **that such statements cannot be regarded as binding statements about the suitability of our products for a particular customer application**. As a rule, EPCOS is either unfamiliar with individual customer applications or less familiar with them than the customers themselves. For these reasons, it is always ultimately incumbent on the customer to check and decide whether an EPCOS product with the properties described in the product specification is suitable for use in a particular customer application.
2. We also point out that **in individual cases, a malfunction of electronic components or failure before the end of their usual service life cannot be completely ruled out in the current state of the art, even if they are operated as specified**. In customer applications requiring a very high level of operational safety and especially in customer applications in which the malfunction or failure of an electronic component could endanger human life or health (e.g. in accident prevention or life-saving systems), it must therefore be ensured by means of suitable design of the customer application or other action taken by the customer (e.g. installation of protective circuitry or redundancy) that no injury or damage is sustained by third parties in the event of malfunction or failure of an electronic component.
3. **The warnings, cautions and product-specific notes must be observed.**
4. In order to satisfy certain technical requirements, **some of the products described in this publication may contain substances subject to restrictions in certain jurisdictions (e.g. because they are classed as hazardous)**. Useful information on this will be found in our Material Data Sheets on the Internet (www.epcos.com/material). Should you have any more detailed questions, please contact our sales offices.
5. We constantly strive to improve our products. Consequently, **the products described in this publication may change from time to time**. The same is true of the corresponding product specifications. Please check therefore to what extent product descriptions and specifications contained in this publication are still applicable before or when you place an order. We also **reserve the right to discontinue production and delivery of products**. Consequently, we cannot guarantee that all products named in this publication will always be available. The aforementioned does not apply in the case of individual agreements deviating from the foregoing for customer-specific products.
6. Unless otherwise agreed in individual contracts, **all orders are subject to the current version of the "General Terms of Delivery for Products and Services in the Electrical Industry" published by the German Electrical and Electronics Industry Association (ZVEI)**.
7. The trade names EPCOS, BAOKE, Alu-X, CeraDiode, CSMP, CSSP, CTVS, DeltaCap, DigiSiMic, DSSP, MiniBlue, MiniCell, MKK, MLSC, MotorCap, PCC, PhaseCap, PhaseCube, PhaseMod, PhiCap, SIFERRIT, SIFI, SIKOREL, SilverCap, SIMDAD, SiMic, SIMID, SineFormer, SIOV, SIP5D, SIP5K, ThermoFuse, WindCap are **trademarks registered or pending** in Europe and in other countries. Further information will be found on the Internet at www.epcos.com/trademarks.